

ENVIROFAN

Silver Line

48C-9

Specifications:

Size: 48"
Weight: 16 lbs.
CFM: 21,500
Area: 1,600 sq. ft.
RPM: 320
Velocity: 600 ft./min.
Amps: .61
Volts: 120V, 60Hz

Safety Cable: 13"

Lead Wires: 20" (From top of bell)

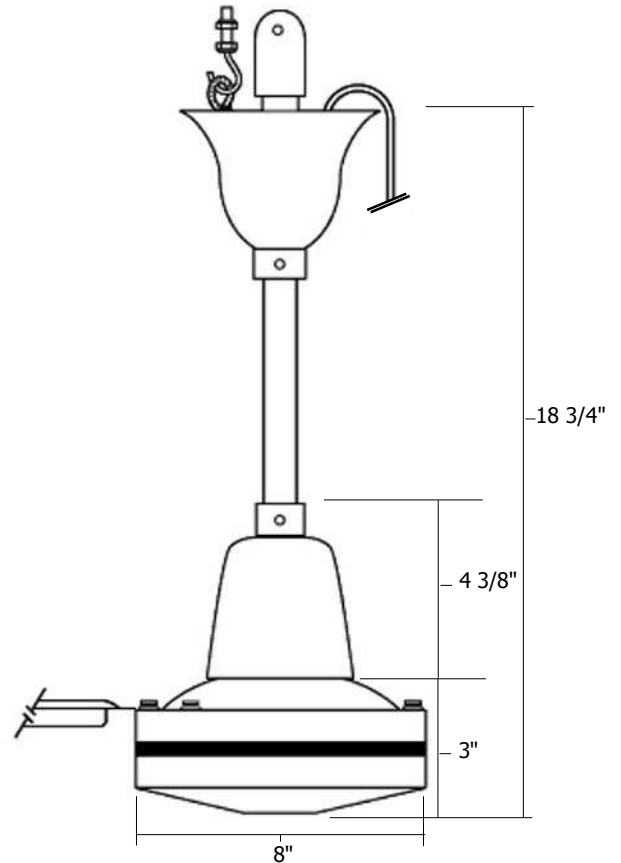
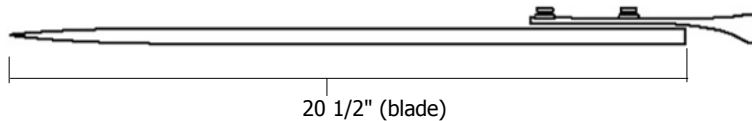

Features:

Thermo Protected Motor
Secondary Support Cable
Stamped Steel Motor Housing
Steel Blades
UL Listed - Meets all 507 standards
3 year warranty
10" Downrod (1/2" i.d.)



Note:

To reduce risk of injury to persons, install fan so that blades are at least 10 feet above floor
Technical specifications subject to change without notice

Northwest Envirofan

A Division of Northwest Environmental Systems, Inc.

Envirofan Ceiling Fans • Protecto-Guard Ceiling Fan Guards • Fan Controls

800-236-7080

(920) 235-7808

FAX (920) 235-3049